



# • Print Emporium •

specialists in full colour print & design

## technicalguide

YOUR GUIDE TO PRODUCING PROBLEM FREE FILES

Version August 2010

---

Print Emporium • 1488 Wimborne Road • Bournemouth • BH11 9AA • 01202 590848  
[www.printemporium.co.uk](http://www.printemporium.co.uk) ~ [www.subwayprinting.co.uk](http://www.subwayprinting.co.uk) ~ [www.1488print.co.uk](http://www.1488print.co.uk)

# CONTENTS / CHECKLIST

This guide will cover the key elements you must be aware of when creating a file for print.

Please use this as a checklist when designing your job and submitting it for print.

## the basics

<input type="checkbox"/>	<b>SIZES</b>	page 3	<input type="checkbox"/>	<b>FOUNTAIN FILLS</b>	page 6
<input type="checkbox"/>	<b>TRI-FOLD LEAFLETS</b>	page 4	<input type="checkbox"/>	<b>SPOT TO PROCESS</b>	page 6
<input type="checkbox"/>	<b>BLEED</b>	page 5	<input type="checkbox"/>	<b>VECTOR/BITMAP COLOURS</b>	page 6
<input type="checkbox"/>	<b>COLOURS</b>	page 6	<input type="checkbox"/>	<b>SPOT UV</b>	page 6
<input type="checkbox"/>	<b>SPOT COLOURS</b>	page 6	<input type="checkbox"/>	<b>FORME CUT</b>	page 8
<input type="checkbox"/>	<b>RGB COLOUR</b>	page 6	<input type="checkbox"/>	<b>IMAGES</b>	page 9
<input type="checkbox"/>	<b>OVERPRINT COLOURS</b>	page 6	<input type="checkbox"/>	<b>FONTS</b>	page 9
<input type="checkbox"/>	<b>BLACK</b>	page 6	<input type="checkbox"/>	<b>QUIET BORDER</b>	page 9
			<input type="checkbox"/>	<b>COLOUR DENSITY</b>	page 9

## booklets

<input type="checkbox"/>	<b>THE BASICS</b>	page 7
--------------------------	-------------------	--------

## service types

<input type="checkbox"/>	<b>SERVICES &amp; FILE FORMATS</b>	page 10
--------------------------	------------------------------------	---------

## print ready

<input type="checkbox"/>	<b>PDF CREATION</b>	page 7	<input type="checkbox"/>	<b>LARGE FORMAT</b>	page 8
--------------------------	---------------------	--------	--------------------------	---------------------	--------

## how to send files to print

When you have your files ready you can either:

- **Upload** when placing your order online.
- **Upload** these via our *ftp server* - <https://dropbo.yousendit.com/printemporium>
- **Post** a CD or Memory Stick to Print Emporium, 1488 Wimborne Road, Bournemouth BH11 9AA.
- **Drop off** your files at the above address.

If you have any further queries about submitting your files, please call our technical team on 01382 400150.

# the basics SIZES

## Standard page sizes for your design jobs:



**Other Sizes:** A2 594mm x 420mm (596mm x 422mm incl. bleed)

# TRI-FOLD LEAFLETS

A little more set up time is required when designing a Tri-fold leaflet.  
Below is a template showing the basic setup of the panels in your document

## A4

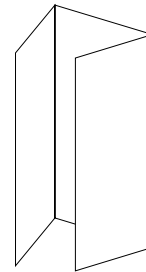
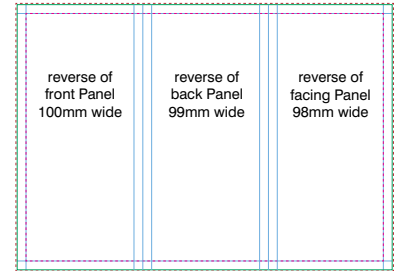
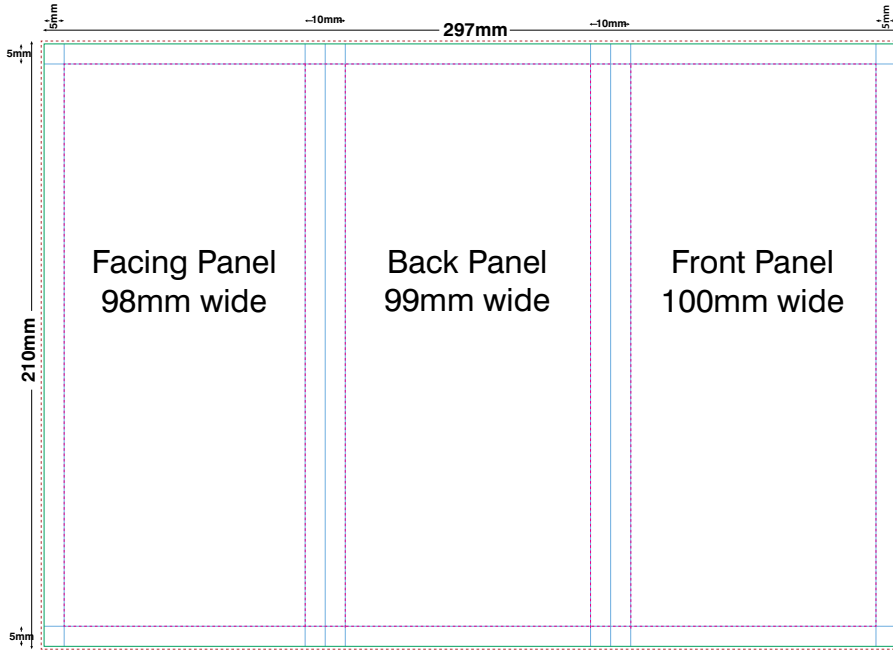

- ..... no text beyond this line
- gutters and borders
- ..... 1mm bleed
- finished page edges

## A3

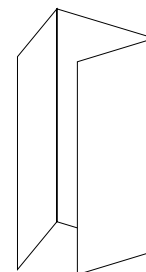
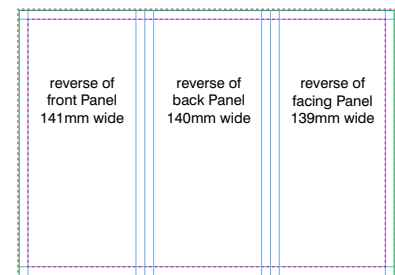
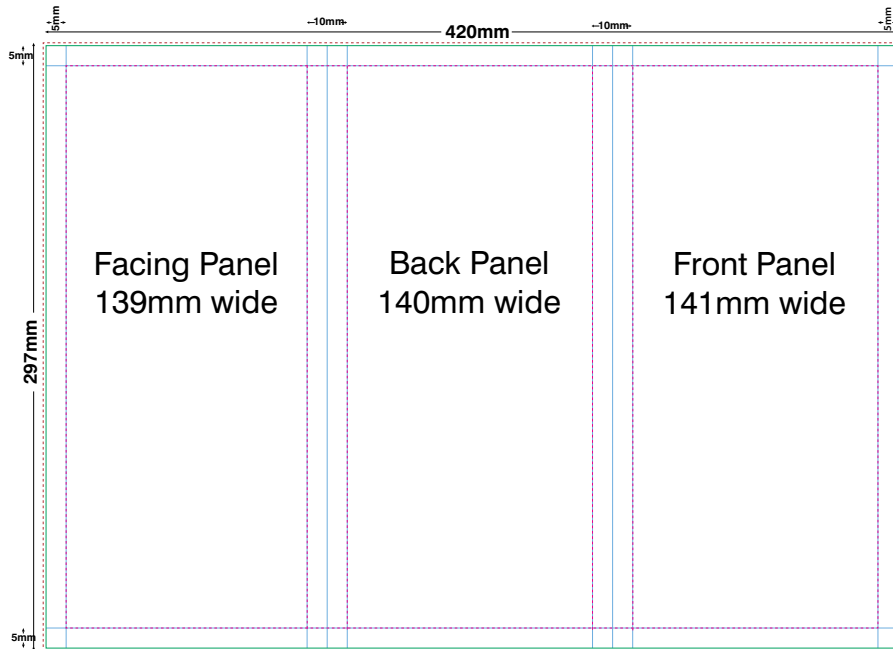

- ..... no text beyond this line
- gutters and borders
- ..... 1mm bleed
- finished page edges

### TOP TIP

Try making up your own folded sample to check it works before sending to us for print.

# BLEED



Bleed edge

**NO BLEED REQUIRED**



Bleed edge

**BLEED REQUIRED**

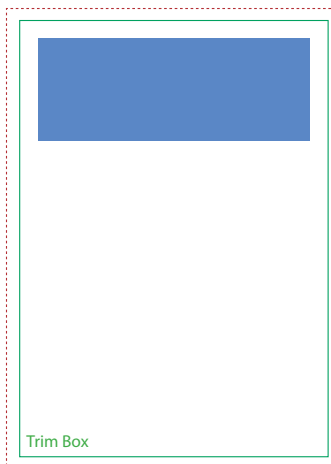

Bleed edge

**NO BLEED REQUIRED**

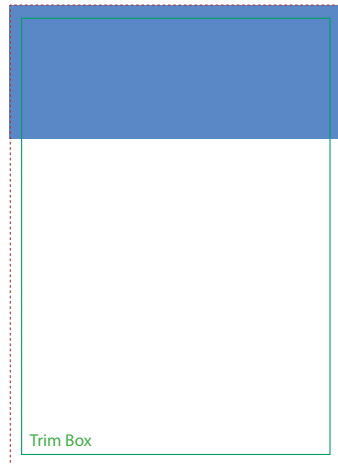

Bleed edge

**BLEED REQUIRED**

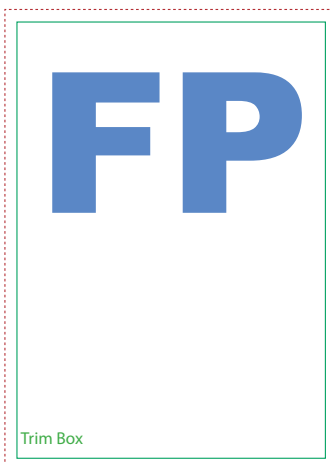

Bleed edge

**NO BLEED REQUIRED**

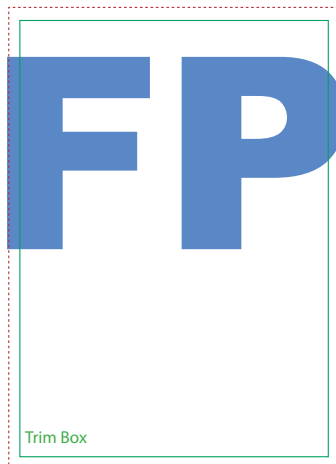

Bleed edge

**BLEED REQUIRED**

Please ensure all jobs have 1mm bleed if required. To determine if bleed is required please see diagrams on this page.

Bleed is required when images, colour or text go right to the edge of your page. To create a bleed simply extend your image(s), colour(s) or text 1mm over the edge of the page

## TOP TIP

For a more professional look, keep a quiet border of at least 5mm from the trimmed edge of your artwork, and avoid the risk of essential info being trimmed off.

**PLEASE NOTE:** If making a PDF for print, please make your PDF page size large enough to incorporate the bleed i.e. if your flyer is A5 with bleed, make your PDF page size A4, etc.

# COLOURS

## Spot Colours



Please ensure all colours in spot colour jobs are assigned Pantone colours (or are 'Black'). CMYK and RGB colour used in spot colour jobs will result in your job being rejected.

**PLEASE NOTE: Do not use fountain fills in spot colour jobs as this will cause your job to be rejected.**

## RGB Colours



Please do not use RGB colour for fills and outlines in full colour jobs as the resulting colour may not be as expected once converted to CMYK for print.



## Overprint Colours



Please note that if you accidentally set a fill or line to overprint, the final printed job will NOT look as it does in your design file, since all inks are transparent.

*(Top Tip: Once you have created your PDF for printing (see page 7) view it In Acrobat Professional and go to the drop down menu Advanced/Print Production and activate Overprint Preview. In this view you will be able to see if you have inadvertently left any Overprints on your job. Try it with this Technical Guide PDF. Overprints are also identifiable by printing separations.)*

## Black



Please ensure all black text and fills have the colour value C0 M0 Y0 K100. Try to keep text below 12pt in black whenever possible, as small coloured text may not look as sharp once printed. Large solid areas of black can be 'beefed up' with the addition of 60% Cyan (C60 M0 Y0 K100) resulting in a deeper looking black known as 'rich black'.

## Fountain Fills & Transparencies



Please do not use fountain fills in spot colour jobs as this will cause your job to be rejected. Fountain fills in full colour jobs are fine.

**PLEASE NOTE: If you have a spot colour job containing a fountain fill please supply us the native design file as File Assist and we will convert the fountain fills to a printable format.**

Please do not use transparencies in Microsoft Word or Publisher as this will result in your job being rejected. Please flatten any transparencies in Adobe Illustrator prior to submitting your file.

## Spot to Process Colour Conversion



When Pantone colours are converted to CMYK for full colour printing a change in colour is inevitable, it is impossible to exactly replicate spot colours using CMYK inks.

Similarly, with RGB images, when they are converted to CMYK, there is a colour shift.

Please allow for this colour shift when designing your job.

## Vector/Bitmap Colours



Please note that areas of colour which have vector fills will appear different to areas of colour which have bitmap fills **once printed** even when the colour values are identical. This will be more pronounced if RGB colour has been used after the conversion to CMYK has taken place. **The solution is to extend your bitmap colour out in a bitmap package (such as Photoshop) avoiding the joining of vector and bitmap colour completely.**

## Spot UV



When supplying Spot UV jobs you must also supply a PDF of the areas which need spot UV'd. The PDF should consist of black solid shapes in the exact position where the spot UV is required, ideally 1mm bigger all round to allow for easier register. Please add an outline to any text which needs spot UV'd, again to help with register (the larger the text, the thicker the outline should be added). **It is not recommended that small text is Spot UV'd.**

# BOOKLETS



## PAGE SIZES

**A6** 105 x 148mm    **A5** 148.5 x 210mm    **A4** 210 x 297mm

## TOP TIP

Avoid content which crosses two adjoining pages.

## PAGE ORDER

The booklet page total must be divisible by 4. Please supply your booklets in single-page format running in the correct order from start to finish *i.e. a 20 page booklet will run from pages 1-20, page 1 being the front cover and page 20 being the back cover (please do NOT place the back cover on Page 1)*. **Please do not supply your booklet as printers' pairs or as spreads.**

## CREEP

The closer you get to the centre pages of a booklet, the more has to be trimmed off the page edges. Our imposition software does make allowances for this. However, it is recommended that you do not have text (esp. page numbers) or images too close to the edges of your booklet pages. A gap of at least 10mm is recommended on all edges.

## print ready PDF CREATION

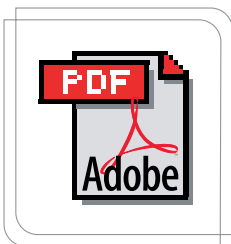

Please create PDF and EPS files from vector packages (Corel, Freehand, Quark, Illustrator, etc). Please do not save files from vector packages as Tiffs or Jpegs.

Please create Tiffs and Jpegs from bitmap packages (Photoshop, Photopaint, PhotoImpact, etc). Please do not save files from bitmap packages as PDFs or EPSs.

### ACCEPTED PRINT READY FILE FORMATS:

- PDF
- JPEG
- TIFF
- EPS

**PLEASE NOTE: EPS files MUST be supplied with crop marks to show where the job is to be cut.**

## PDF CREATION

When creating your PDF to submit for print please use a recognised PDF-maker such as Acrobat Distiller to make your PDF. Using a design package's own PDF maker may result in your job being rejected.

Always save as a **High Quality** or **Print Quality** PDF.

If using **Acrobat Distiller** then choose **PDF/X-1a:2001** from the drop-down list.

When creating your PDF please embed all fonts.

If your job has a bleed please ensure you choose a large enough PDF page size to accommodate the bleed *i.e. if you design an A6 flyer with a bleed, make your PDF page size A5.*

Please create your PDF with crop marks if possible.

Please supply all files as 1up as we will deal with the imposition at this end.

# LARGE FORMAT

**PLEASE NOTE:**  
Large format printing utilises a different print technology to lithographic print. This means colours may not be an exact match to your litho jobs.

## POSTERS

All posters should have 3mm of bleed regardless of their finished size and quiet borders should be at least 10mm. However, if the finished product is to sit inside a frame allow for a larger quiet border for size of the frame. Graphic resolution should be no lower than 150dpi.

## BANNERS

Banners require a 15mm bleed, which will allow the image to wrap round for stitching the edges. A quiet border of at least 10mm is recommended and images no lower in resolution than 150dpi.

# HAIRLINES

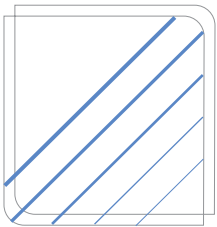

## Hairlines are 'device dependent'.

Because hairlines are device dependent they could print differently on different printers. Often they may look fine on your 300dpi laser printer but will disappear on our 2400dpi press. Therefore avoid hairline text and lines - use 0.25pt.

# 'NO PROOFING' SERVICE

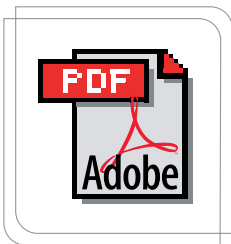

## NO PROOFING

We offer a no proofing service available to experienced clients who are confident in supplying the file correctly for print in guidance with our technical specifications.

This service means you will not receive a proof of your job, this applies to print ready jobs only. Instead when your file is supplied for print we will process it as usual and send it to print directly without sending you a proof and waiting for confirmation to print. This can save time and give your jobs a quicker turn around.

If you are confident you can supply your print ready files in the correct manner for print and would like to join the no proofing service, please contact us.

# FORME CUT

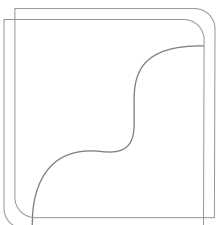

## FORME CUT

When supplying Form Cut jobs you must also supply a PDF of the cutting form you require. This should consist of a black hairline in the exact shape and size of the cuts/creases you require, which will be used to produce a cutting form for your job. Cuts should be denoted by a solid black hairline, creases should be denoted by a dotted black hairline.

# IMAGES



Please try to ensure all images in your design file are high-res, the standard for which is 300dpi (dots per inch). The lower the dpi the worse your image(s) will look when printed, so please bear this in mind when scanning, manipulating or sourcing images for your job.

**PLEASE NOTE:** Images and logos saved from websites are most likely to be between 72-96dpi and are therefore unsuitable for print.

We highly recommend images to be CMYK, any RGB images will be converted to CMYK in our workflow which may result in a small colour shift (see p6 for details).

**Sourcing Images** - always try and use professional images, low quality images will only downgrade your designs. Images can be purchased from our image library. Go to [www.shutterstock.com](http://www.shutterstock.com) find an image, send us the reference number, and we will send you the image for a small cost.

## NOTE:

Anything above 450dpi will be downsampled to 300dpi in our workflow.

# FONTS



## Print Ready jobs

**PDF** – please ensure you embed all fonts when making your PDF.

**EPS** – please ensure you convert all fonts to outlines when making your EPS.

## File Assist jobs

Please ensure all fonts used in your design file are included with your job, or converted to curves/paths/outlines prior to submission. **Your minimum font size should be 5pt.**

# QUIET BORDER

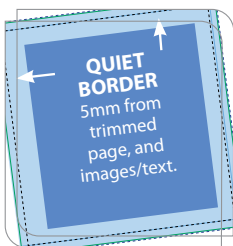

A “Quiet Border”, (i.e. an area where no text or logos should be present), of at least 5mm from the trimmed edge of your artwork should be observed. This will avoid any part of your design appearing too close to the edge of the page and will give your job a more professional appearance.

For A5 - A4 booklets we recommend 10mm quiet border for a much better finish.

# COLOUR DENSITY



Please ensure that your total CMYK colour values do not add up to more than 340% as this density of ink may cause set-off and mark the reverse of your job. This would give a maximum colour value of C 85 M 85 Y 85 K 85 or equivalent, although it is recommended that colours should be kept well below this maximum. Please be extra careful if RGB colour has been used, as RGB colours often exceed this maximum once converted to CMYK.

# SERVICES & FILE TYPES

## PRINT READY

NO  
CHARGE

**PLEASE NOTE:** All print ready files must be created in accordance with our technical guide. It is the client's responsibility to ensure that the technical specifications are met, failure to do so may result in additional charges and a delay to your print deadline. Any printing errors caused by failure to adhere to the technical guide will be at the client's expense. If in any doubt please opt for our 'File Assist' option.

### Acceptable file formats:

- PDF (HIGH-RES)
- EPS (WITH CROP MARKS)
- TIFF (HIGH-RES)
- JPG (HIGH-RES)

### File specifications:

- 1mm bleed (where required)
- Fonts outlined or embedded

Please ensure all images in your native design file(s) are high-res before saving/exporting for print

PDF & EPS are preferred from vector packages (please don't rasterise)  
TIFFs & JPEGs will be sent straight to print without proofing

### What we'll do now

We will provide a low-res proof for PDF and EPS files for approval before print.

Files may be resupplied once only at no additional cost. Further submissions will be charged at £15.

### What we won't do

Check spelling.  
Make amendments to the file.  
Fix any technical issues with the file.

## FILE ASSIST

£15

You've put together the design that you'd like. We'll make it Print Ready for you.

(Please refer to our technical guide before you submit your file.)

### Acceptable file formats:

Adobe Creative Suite  
(Illustrator, Photoshop, InDesign)  
All Versions PC & Mac

Adobe Pagemaker From 5 onwards PC

CorelDRAW All Versions PC

Freehand From 5 onwards PC & Mac

Microsoft Office Word, Powerpoint, Publisher  
from MS Office98 onwards - PC & Mac

Quark Express Versions 5 - 6.5 PC & Mac

### What you should include:

- Fonts
- All linked files

Please ensure all images in your file are high-res and you have included a 1mm bleed where appropriate.

THERE WILL BE AN ADDITIONAL CHARGE FOR BOOKLETS DUE TO SIZE OF THE FILES.  
YOUR ACCOUNT MANAGER WILL ADVISE YOU ON THIS.

### What we'll do now

Make the technical changes required to make your file Print Ready.

Advise if there are any missing elements that will be needed to make it Print Ready.

Provide up to 2 proofs.

### What we won't do

Check spelling.  
Check contact info - addresses, tel no's etc.

### For an additional charge we can

Make text changes.  
Make layout changes.  
Provide more than 2 proofs.

## DESIGN

£30  
PER HOUR

Use our expert design team to put together your job for you. Simply provide us with a few details and we will do the rest for you, or if you have a basic design put together but needs tweaking we can help too.

### • TEXT

Please provide us with all of the text you'd like in your design either in an email or ideally supplied to us in Microsoft Word.

### • IMAGES

Supplied - if you have your own high res images you'd like to include

Sourced - we can find the perfect images for you from our extensive images libraries.

### • LAYOUT INFO

Any info on preferred colours / layout / style.

### • COMPANY LOGO

If you have a company logo you'd like to include, please supply it as an eps, tiff or jpeg.

### • TARGET GROUP

Who are you targeting?

### • ANY OTHER INFO

Any other comments/info which you think may help.

### What we'll do now

Put together a design for you based on the information you have provided.

Email a PDF proof.

2 proofs are included in your initial quote.

### For an additional charge we can

Source good quality images.  
Extract text from printed or written copy.  
Provide more than 2 proofs.

WE WILL PROVIDE YOU A QUOTE  
BASED ON THE INFORMATION YOU PROVIDE US.

# NOTES

Print Emporium • 1488 Wimborne Road • Bournemouth • BH11 9AA • 01202 590848

---

[www.printemporium.co.uk](http://www.printemporium.co.uk) ~ [www.subwayprinting.co.uk](http://www.subwayprinting.co.uk) ~ [www.1488print.co.uk](http://www.1488print.co.uk)